

**LEHNER**  
LIFTTECHNIK

**SSS**  
Elevators & Escalators  
+961 25 803965 | +961 81 060 038



# PORTFOLIO

OUR LIFT SYSTEMS

# WORLDWIDE ESTABLISHED

High-quality lifting solutions for more than 30 years



## DEAR CUSTOMERS!

Lehner Lifttechnik - Welcome to a world of barrier-free mobility. All our daily efforts are aimed at enabling the users of our products to live a barrier-free life.

Since my father founded the company over 30 years ago, our team has been working to make everyday life easier for people with mobility impairments with our reliable lifts.

We stand for affordable and at the same time high-quality lift systems. We always aim to offer our customers outstanding products at attractive prices. As a full-range supplier, our portfolio offers 13 lift solutions for a wide variety of situations. In addition to chair stairlifts and platform stairlifts, this also includes vertical platformlifts.

Thanks to the use of high-quality components and robust constructions, our products convince with durability and smooth operation. Manufacturing according to the highest European standards as well as well thought-out safety features ensure reliable use for years.

We are proud to be able to give people back a bit of independence with our lifting solutions.



**Christian Lehner**  
Managing Director



**80**

COUNTRIES  
SERVED



**>45,000**

INSTALLED  
LIFTS



**95**

EXPORT  
IN PERCENT



**32**

YEARS OF  
EXPERIENCE



**353**

SALES  
PARTNERS



# PRODUCT PORTFOLIO

Discover our wide range of lift systems

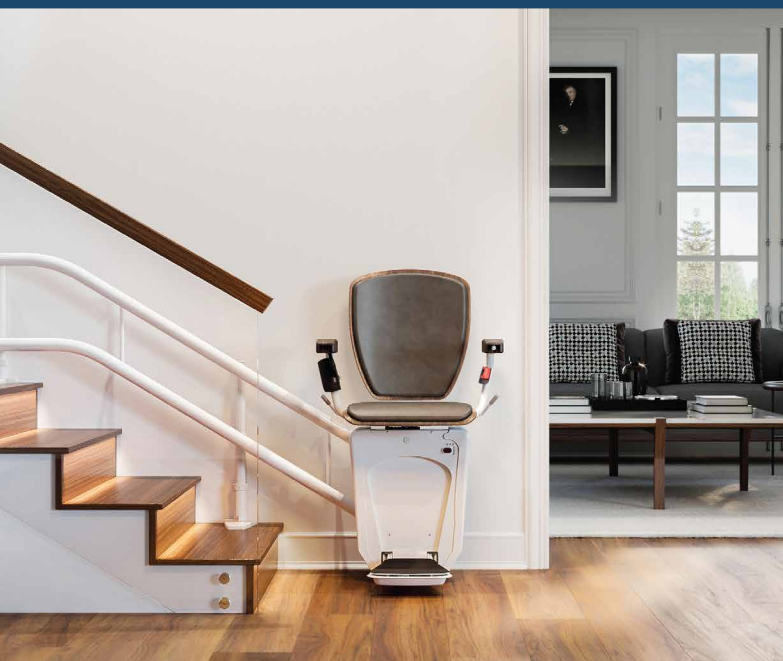

## CHAIR STAIRLIFTS

- 6 | Alpha
- 8 | Essential

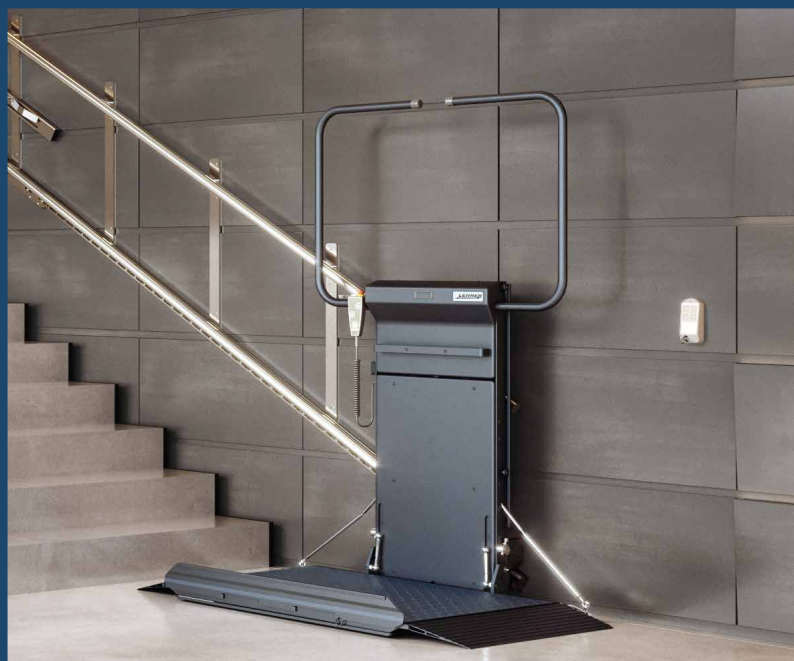

## PLATFORM STAIRLIFTS

- 10 | Delta
- 11 | Stratos
- 12 | Omega



## VERTICAL PLATFORMLIFTS

- 16 | Liftboy 1-3
- 17 | Liftboy 4
- 18 | Liftboy 5
- 20 | Sigma
- 22 | Elevex

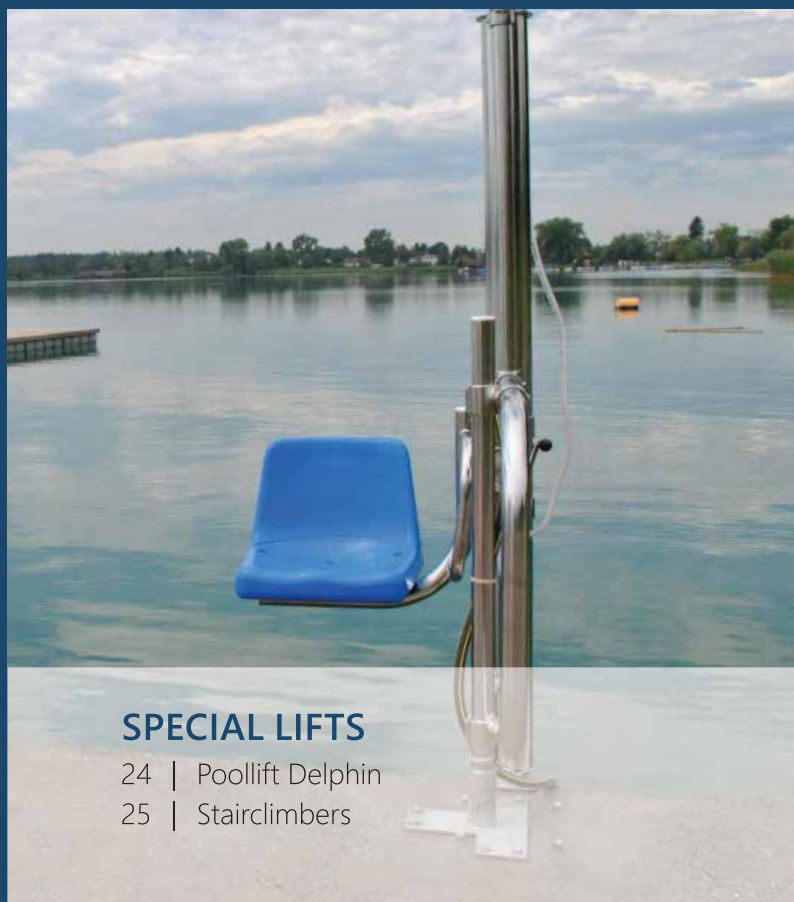

## SPECIAL LIFTS

- 24 | Poollift Delphin
- 25 | Stairclimbers





”

We are proud that our lift systems help people all over the world to live a barrier-free life every day.

“

Max Lehner, Company founder



# CHAIR STAIRLIFTS



ALPHA



ESSENTIAL





# ALPHA

Chairlift for curved stairs



## DESIGN

Wide range of seat designs choosable to suit any taste



## RELIABLE

Approved and robust system with two rails for safe operation



## FLEXIBLE

Many options allow adaptation to various conditions





# ALPHA

Flexible options for any situation

Chair stairlifts | 6/7



Outdoor installation



Wall mounting

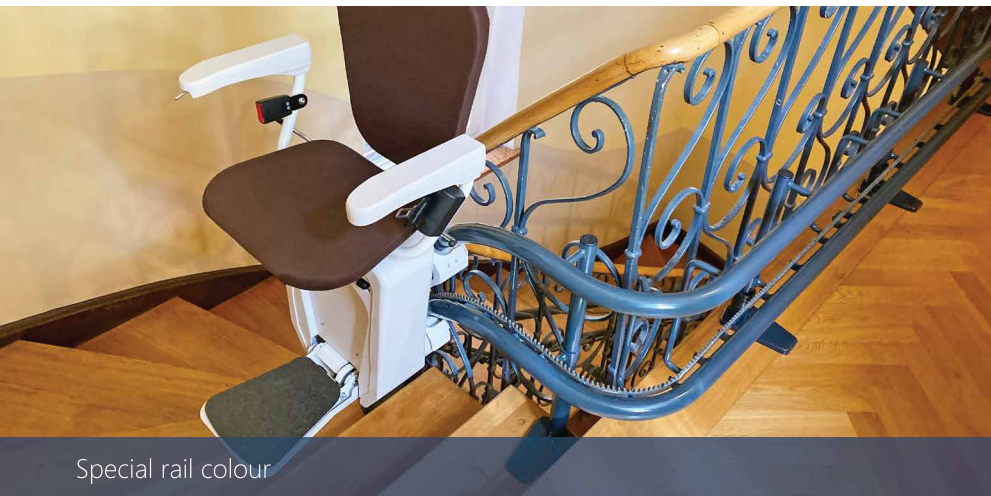

Special rail colour

## SEAT FABRICS CHOICE

Classic Line



Blue



Red



Brown



Green



Beige



Light beige (waterproof)

Premium Line



Marine blue



Emerald green



Ruby red



Pearl white



Walnut brown



Safran yellow

Exclusive Line



Olive (WT)



Granit (WT)



Bordeaux (WT)



Basalt (AT)



Burgundy (AT)



Mocca (AT)



Ivory (WT)



Marble (WT)



Creme (AT)

AL = artificial leather | WT = wooven textiles

## Specifications

<b>Loading capacity</b>	130 (optional 145) kg
<b>Drive system</b>	Rack and pinion
<b>Motor</b>	24 V DC, battery driven
<b>Gradient</b>	0 - 52°
<b>Speed</b>	0.06-0.12 m/s
<b>Max. rail length</b>	35 m
<b>Noise level</b>	Under 50 dB
<b>Temperature</b>	+45 to -15 °C
<b>Power supply</b>	1 × 230 V / 50-60 Hz
<b>Certificate</b>	TÜV certified to EN 81-40:2020

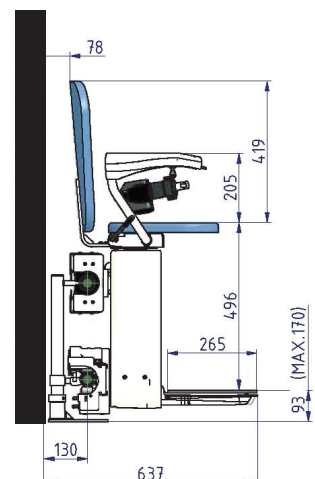
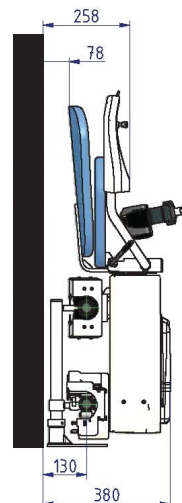



# ESSENTIAL

Chairlift for straight stairs



## HIGHLIGHTS

- Extremely slim lift, only 273 mm when folded up
- Durable product with proven mechanics
- Quiet and stable driving characteristics
- Reliable safety devices



## ALL-ROUNDER

The advantage of chair stairlifts is their space-saving design compared to other lifts. They can be installed in almost all staircases and do not require any structural changes on site.

## Specifications

Loading capacity	140 kg
Gradient	30 - 55°
Speed	0.08 m/s
Motor	24 V DC, battery driven
Drive system	Rack and pinion
Fold-up width	273 mm
Fold-out width	546 mm
Power supply	1 × 230 V / 50-60 Hz

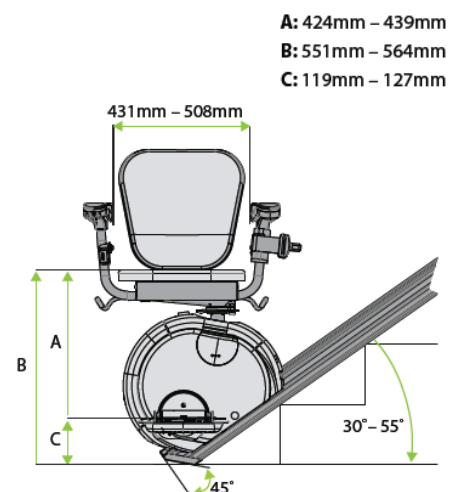
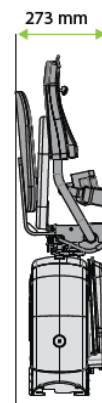

A: 424mm - 439mm

B: 551mm - 564mm

C: 119mm - 127mm



PLATFORM STAIRLIFTS



DELTA

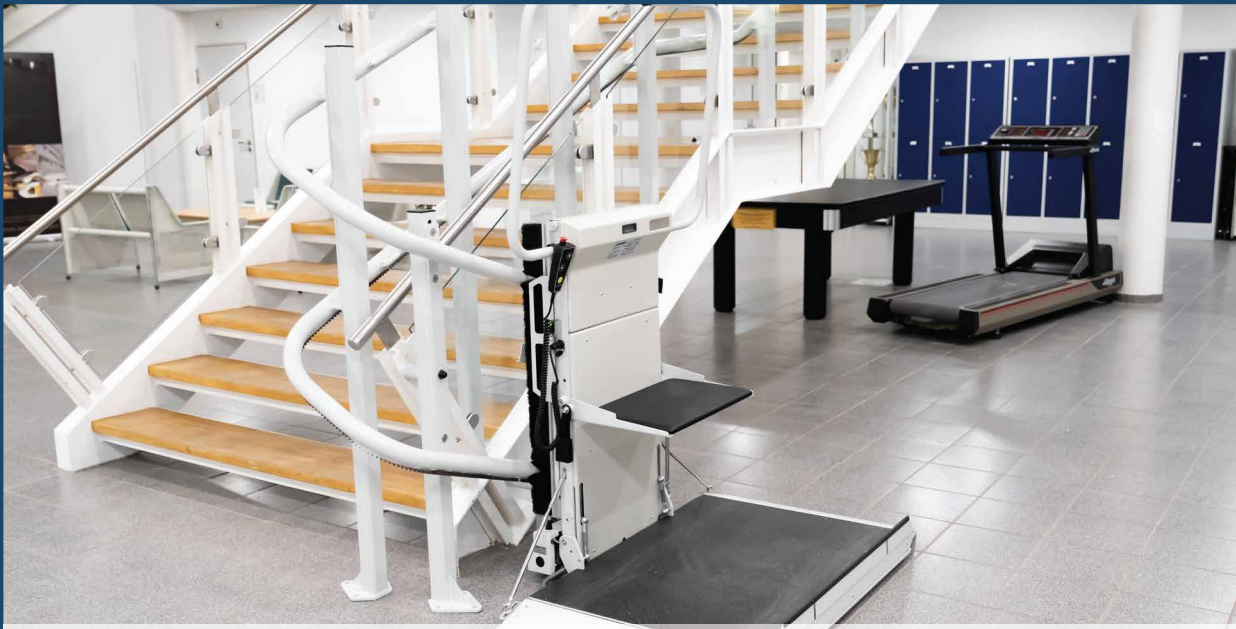

STRATOS

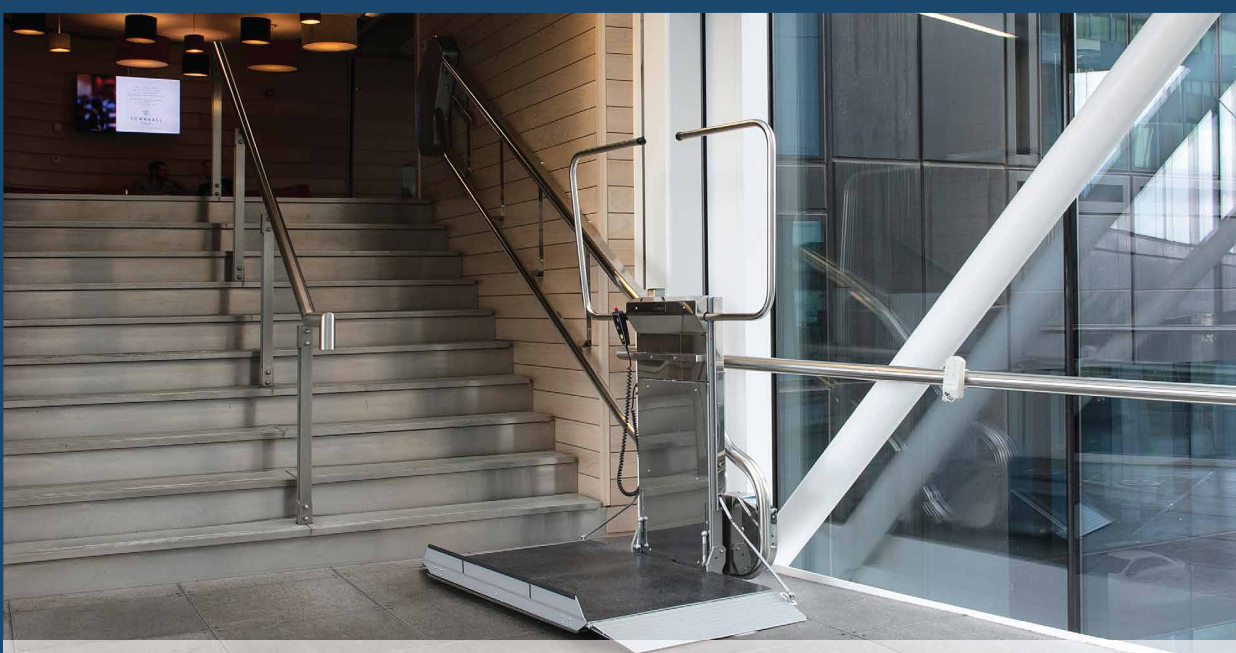

OMEGA



# DELTA

Design lift with rack and pinion drive for straight stairs

## DELTA CONFIGURATOR

With the 3D Delta configurator, the Delta can be configured in seconds and provides the plans for your lift



### COMFORTABLE

Automatic platform functions and ergonomic controls



### EASY

Quick mounting and low maintenance for maximal satisfaction



### SPACE-SAVING

Slim design for largest platform sizes, installation from 890 mm stair width

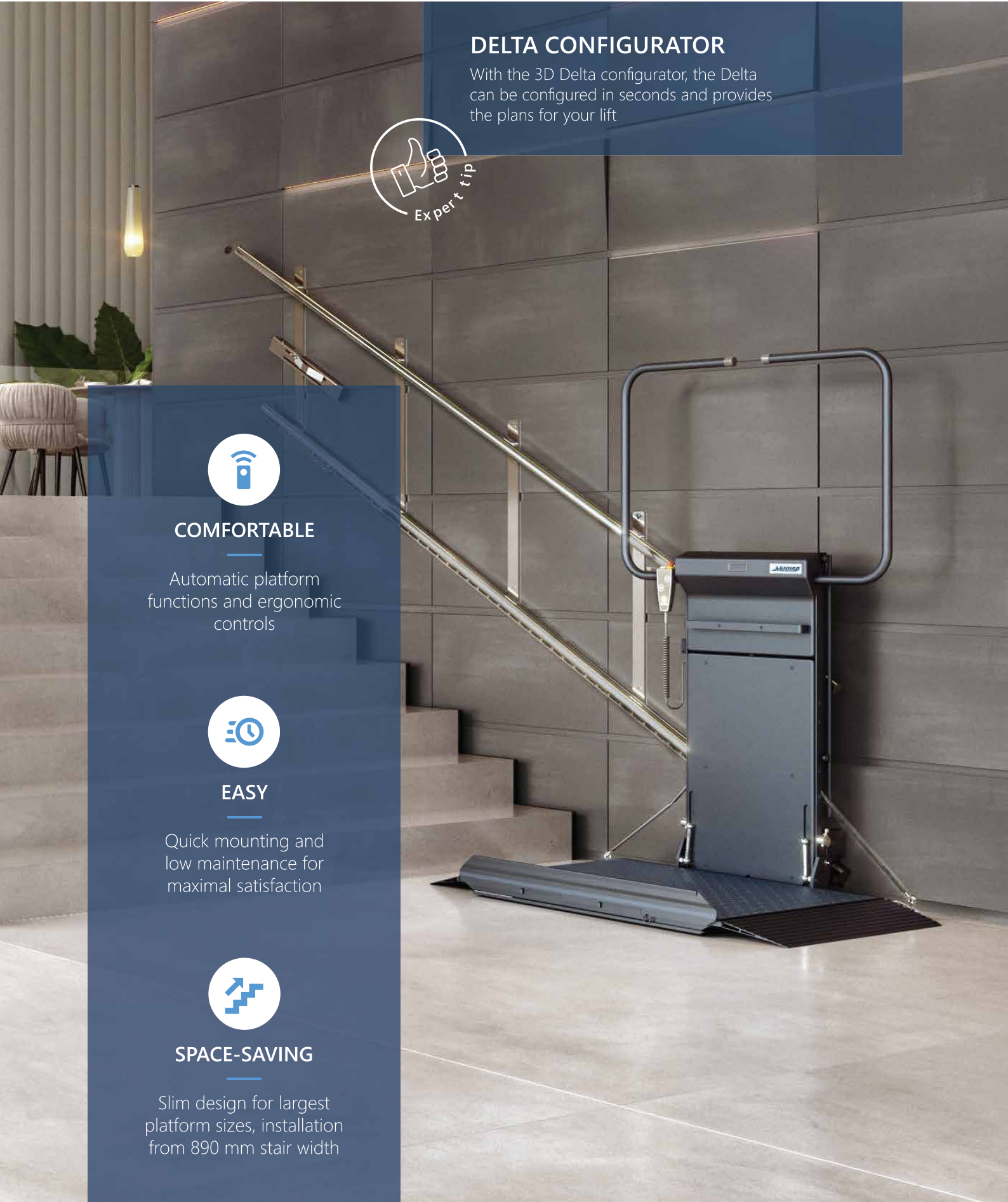



# STRATOS

Platform lift with rack and pinion drive for curved stairs

Platform stairlifts | 10/11



## HANDRAIL

Upper tube remains clean and serves as comfortable handrail



## EFFICIENT

Quick and affordable installation indoor and outdoor



## STABLE

Robust platform mechanics and stable rails guarantee safe operation

## USER VIDEO

In the user video of our platform stairlifts you can see their comfortable operation.





# OMEGA

Specialist for the narrowest staircases

## MULTI-TALENT

The Omega is a real all-rounder. Even for difficult environments, the lift offers a solution. Distances of up to 85 metres, narrowest stair widths or gradients of up to 67 degrees can be overcome with the Omega.

*i*



### VERSATILE

Installation on very steep and narrow stairs possible thanks to cable pull system



### PERMANENT

Permanent power supply without battery for long distances and high user frequency



### COMPACT

Extremely thin construction for installation in very tight staircases



# POSSIBILITIES

Delta, Stratos, Omega

Platform stairlifts | 12/13

## VARIETY

- Coating in all RAL colours
- Installation indoors and outdoors
- Variety of mounting options
- Different platform sizes
- Optional folding seat
- Different rail materials



Stainless steel version



## TÜV CERTIFIED

Our platform stairlifts are TÜV certified according to the current EU standard **EN 81-40:2020**.



Special RAL colour

## CONTROL

- ① **Landing control**  
As handheld control or fixed to the wall
- ② **Handset on spiral cable**  
For comfortable operation while driving
- ③ **Joystick**  
Integrated on the platform



①



②



③

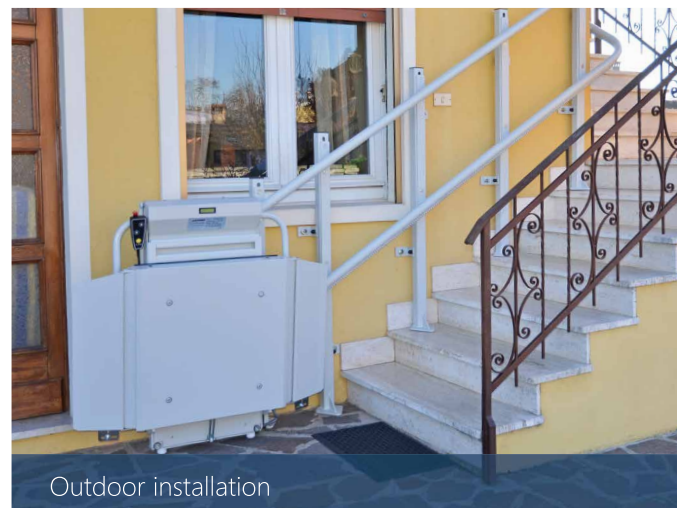



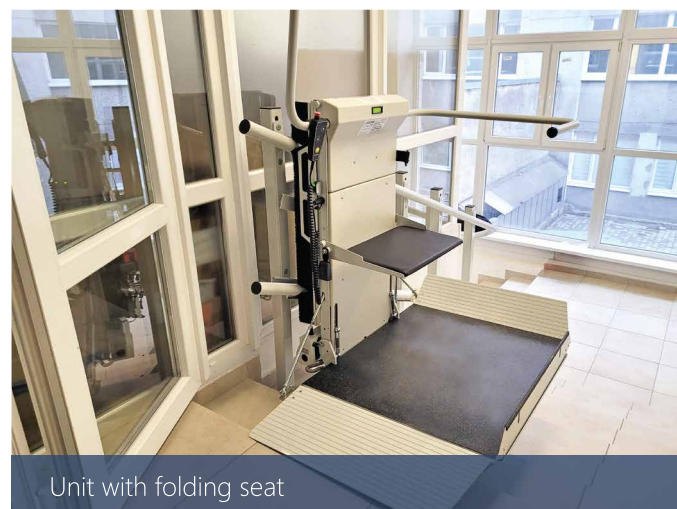



Outdoor installation



Unit with folding seat

# SPECIFICATIONS

## Platform stairlifts

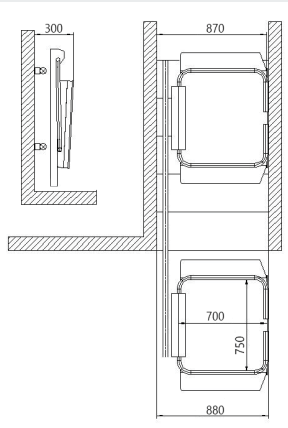
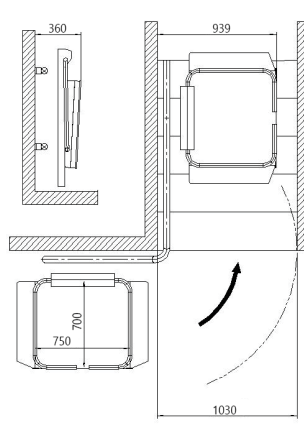
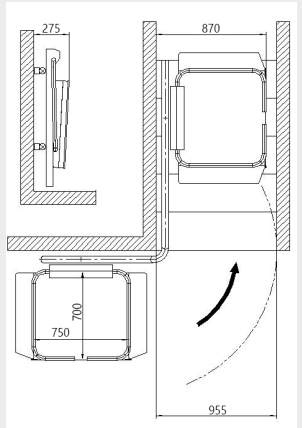
	DELTA	STRATOS	OMEGA
<b>Loading capacity</b>	225 (optional 300) kg	225 (optional 300) kg	225 (optional 300) kg
<b>Platform sizes (standard)</b>	700 x 750, 750 x 850, 800 x 900, 800 x 1000 mm	700 x 750, 750 x 850, 800 x 900, 800 x 1000 mm	700 x 750, 750 x 850, 800 x 900, 800 x 1000 mm
<b>Platform sizes (special)</b>	Max. 900 x 1300 mm	Max. 900 x 1300 mm	Max. 900 x 1300 mm
<b>Gradient</b>	0 - 52°	0 - 47°	0 - 67°
<b>Speed</b>	0.06 - 0.12 m/s	0.06 - 0.1 m/s	0.06 - 0.15 m/s
<b>Noise level</b>	Under 60 dB	Under 60 dB	Under 60 dB
<b>Temperature</b>	+45 to -15 °C	+45 to -15 °C	+45 to -25 °C
<b>Folded width</b>	300 mm	360 mm	275 mm
<b>Power supply</b>	1 x 230 V / 50-60 Hz	1 x 230 V / 50-60 Hz	1 x 230 V / 50-60 Hz
<b>Standard colour</b>	  RAL 9007    RAL 7035	  RAL 9007    RAL 7035	  RAL 9007    RAL 7035
<b>Rack and pinion drive with 24 V motor on platform</b>	✓	✓	
<b>Cable pull system with 3 x 400 V motor at rail end</b>			✓
<b>Drive engine</b>	0.5 kW	0.5 kW	1.1 - 2.2 kW
<b>Max. rail length</b>	30 m	35 m	85 m
<b>Certificates</b>	TÜV certified according to EN 81-40	TÜV certified according to EN 81-40	TÜV certified according to EN 81-40
<b>Dimensions (min)</b>			



# VERTICAL PLATFORMLIFTS

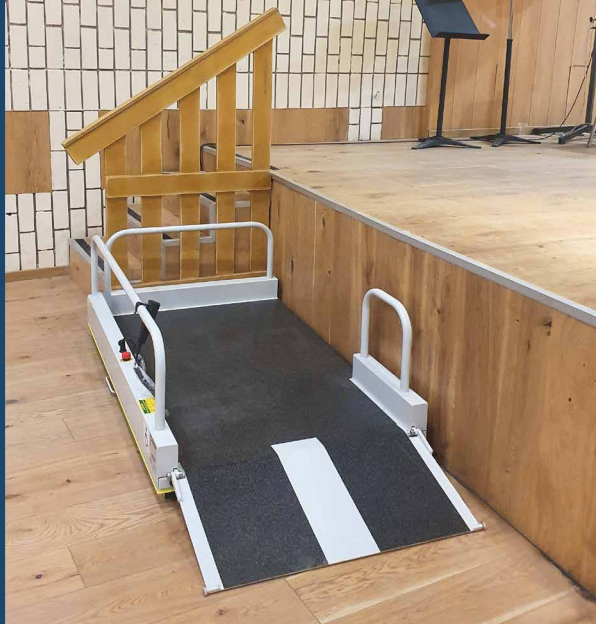

LIFTBOY 1-3



LIFTBOY 4



LIFTBOY 5



ELEVEX



SIGMA





# LIFTBOY 1-3

For height differences up to 970 mm

## OPTIONS

- Coating in any RAL colour
- Indoor and outdoor installation
- Version for public buildings
- Automatic access ramp
- Extra long access ramp
- 90° entry-exit
- External control (radio/wired)
- Contact bars



Door at upper landing, higher lateral barriers and control pillar

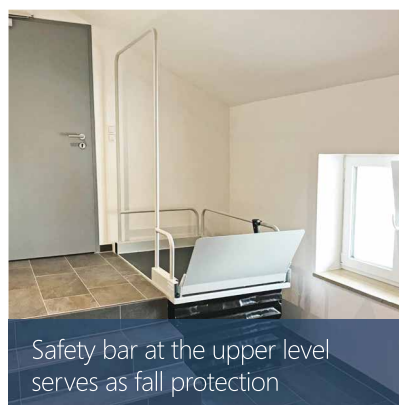

Safety bar at the upper level serves as fall protection



Transport wheels ideal for different places of use

## 3D CONFIGURATOR





# LIFTBOY 4

Mobile lift for height differences up to 1400 mm

Vertical platformlifts | 16/17



## HIGHLIGHTS

- Two lifting heights to choose (model S/L)
- Indoor and outdoor use
- Specially developed for mobile use
- Available in all RAL colours

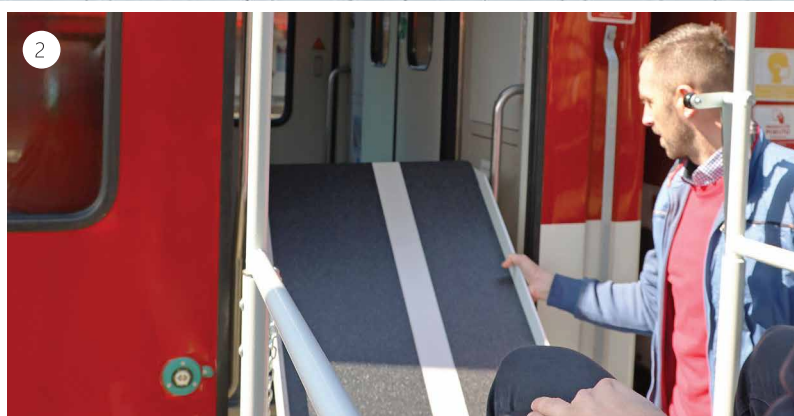

## FUNCTIONALITY

- ① Safety is top priority: This is guaranteed by the integrated emergency lowering
- ② Optimally adaptable to varying demands thanks to the width adjustable ramp (upper stop)
- ③ Intuitive control on the outside of the lift including stop button





# LIFTBOY 5

For height differences up to 1300 mm



## HIGHLIGHTS

- Low minimal platform height of only 125 mm
- Emergency power supply with 24 V battery
- Maximum safety thanks to overload device, emergency lowering and safety bars
- Numerous options: Door on platform, automatic door opener, glas shaft



## EFFICIENT ALTERNATIVE

The need for a lift system often arises unexpectedly and must be met quickly. Vertical platform lifts are then an optimal choice for low lifting heights.

In contrast to escalators, they convince with short delivery times and lower costs.



### Control

Either on platform incl. display with status indication or with radio remote controls



### Pit

Installation is possible with or without pit



# SPECIFICATIONS

## Liftboy 1-5

Vertical platformlifts | 18/19

	TYPE 1	TYPE 2	TYPE 3	TYPE 4 S	TYPE 4 L	TYPE 5
Max. lifting height (mm)	595	830	970	1000	1400	1300
Min. platform height (mm)	100	120	135	182	250	125
Platform width inside (mm)	713	800	800	845	862	900/1100
Platform width outside (mm)	810	924	924	1233	1188	1150/1350
Platform length inside (mm)	1170	1495	1495	1500	1410	1400
Platform length outside (mm)	1180	1505	1505	1628	1571	1572
Loading capacity (kg)	180	300	240	300		315
Speed (mm/s)	10			17		25
Standard colour RAL 7035	✓			✓		✓
Standard colour RAL 9007	✓					✓
1 x 230 V / 50-60 Hz power supply	✓					✓
24 V actuator, scissor mechanism	✓			✓		
24 V actuator, double scissor mechanism					✓	✓
2 x 12 V / 9 Ah battery				✓		✓
Safety curtain	✓			✓		✓



## USER VIDEO

In the Liftboy 1-3 user video, we show the compact lift in use. Convince yourself of the diverse possibilities of the popular lift:

# SIGMA

For height differences up to 3000 mm

## FOR ALL NEEDS

Depending on the requirements, the system can be installed indoors or outdoors. The lifting height is variable up to 3 metres and thereby contributes to the wide range of possible applications of the lift.



### AESTHETIC

Elegant finish with railing at upper landing due to low height



### ROBUST

Ideal for indoor and outdoor use, corrosion protection provided by aluminium components



### SAFE

Thanks to safety floor, innovative safety gear and electric emergency lowering





# SIGMA

Aesthetics and safety combined in one product

Vertical platformlifts | 20/21

## HIGHLIGHTS

- Drive by double chain for smooth operation
- Intuitive control thanks to audio feedback
- Radio external control (either on pillars or portable)
- Integrated access ramp
- Compact design with slim drive tower
- Ideal solution for both public and private buildings - also for retrofitting

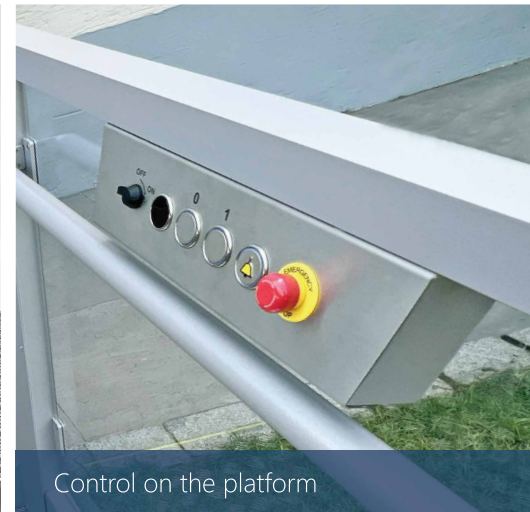

Control on the platform



Platform lighting

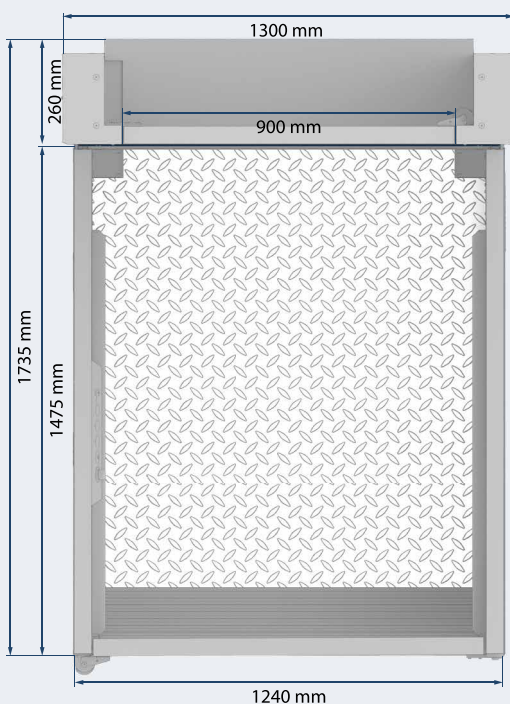

## Specifications

Loading capacity	385 kg
Lifting height	650 - 3000 mm
Max. number of stops	4
Platform size	1100 x 1400 mm
Drive system	Double chain drive
Min. platform height	50 mm
Standard colour	RAL 9022
Noise level	Under 60 dB
Temperature	+45 to -15 °C
Drive engine	1.0 kW
Power supply	1 x 230 V
Emergency power supply	Integrated as standard

# ELEVEX

For height differences up to 1829 mm



## HIGHLIGHTS

- Cost-effective solution for indoors and outdoors
- Free standing drive tower for fast installation
- Faultless and smooth driving characteristics
- Automatic access ramp



Use even in winter thanks to robust construction

## OPTIONAL AVAILABLE



Side exit at upper landing  
Door at upper landing  
External landing control/s

## Specifications

<b>Loading capacity</b>	340 kg
<b>Lifting height</b>	Type 1: 1219 mm   Type 2: 1829 mm
<b>Min. platform height</b>	70 mm
<b>Platform size</b>	914 x 1372 mm
<b>Drive system</b>	Screw
<b>Speed</b>	0.04 m/s
<b>Noise level</b>	Under 60 dB
<b>Temperature</b>	+45 to -30 °C
<b>Drive engine</b>	0.75 kW
<b>Power supply</b>	1 x 230 V / 50 Hz
<b>Conformity</b>	Machinery Directive 2006/42/EC

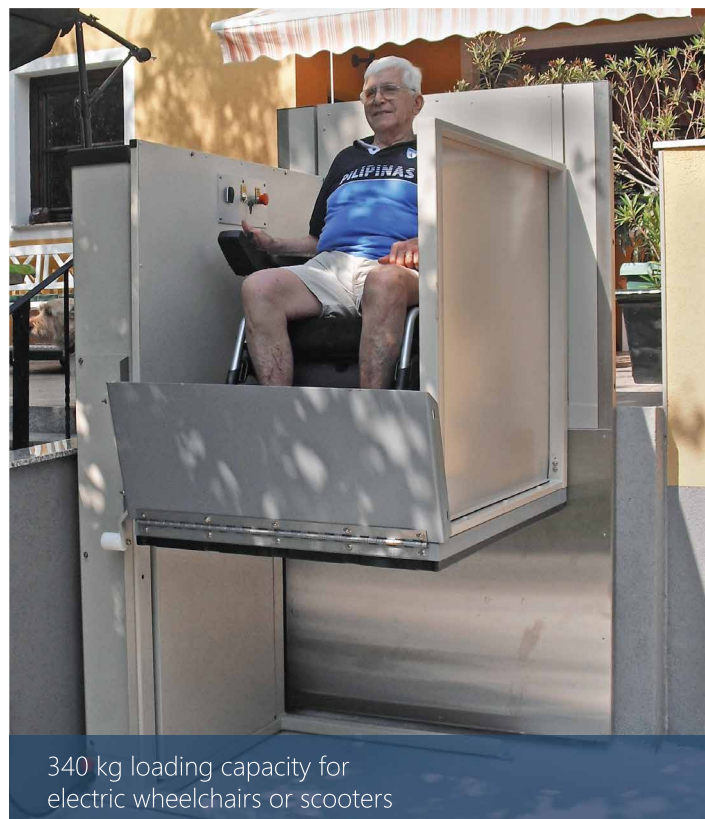

340 kg loading capacity for electric wheelchairs or scooters





”

When we develop products, we always have people and their mobility needs in mind.

“

Christian Lehner, Managing Director



# DELPHIN

Poollift up to 1600 mm lifting height

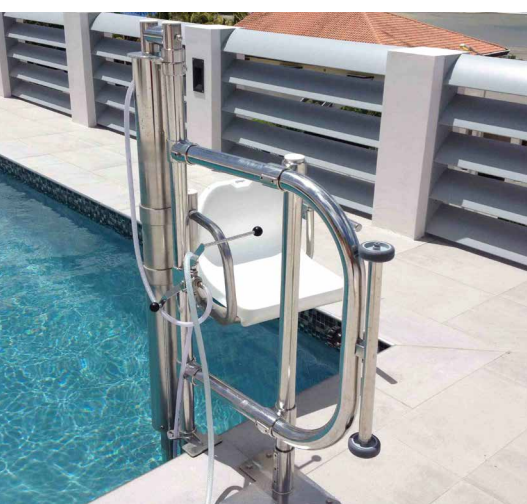

## HIGHLIGHTS

- Independent use, no assistant necessary
- Operated with water pressure
- No electrical components
- Two seat colours selectable (blue and white)
- Can be used for indoor and outdoor pools
- Comfortable operation with control lever



## INSTALLATION

No underwater installation is necessary, one attachment point at the edge of the pool is sufficient. The lift is operated with domestic water pressure.

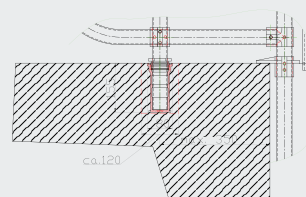

Variant A: **Recessed bracket**

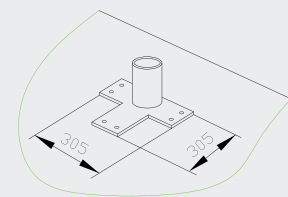

Variant B: **Screwed bracket**

## Specifications

<b>Loading capacity</b>	130 kg
<b>Lifting height standard</b>	1220 mm
<b>Lifting height optional</b>	1067 to 1600 mm
<b>Water pressure min.</b>	4 bar
<b>Water depth min.</b>	1150 mm
<b>Material</b>	AISI 316 stainless steel



# STAIRCLIMBERS

Simple transport method for straight flights of stairs

Special lifts | 24/25



STAIRMAX

## HIGHLIGHTS

- **Unique:**  
The only self-propelled stairclimber
- **Easy:**  
Only a small adaptation necessary
- **Compact:**  
Easy and safe to transport

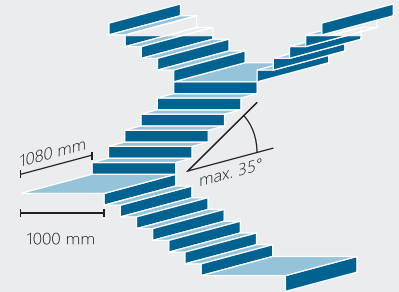

PUBLIC

## HIGHLIGHTS

- **Strong:**  
Use with heavy electric wheelchairs
- **Versatile:**  
Ideal for use in public buildings
- **Durable:**  
High quality product for long usage

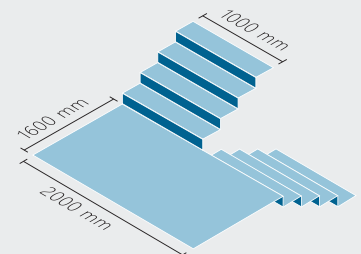

SA-3/SA-S

## HIGHLIGHTS

- **Mobile:**  
Can be used on a wide range of stairs
- **Powerful:**  
Up to 30 floors without effort
- **Stable:**  
Robust construction for safe use

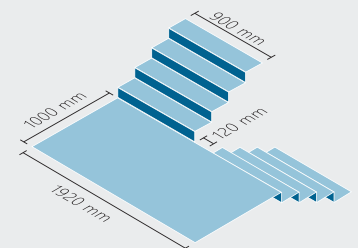

	STAIRMAX	PUBLIC	SA-3	SA-S
Loading capacity	110 kg	200 kg	160 kg	150 kg
Net weight	54 kg	115 kg	65 kg	59 kg
2 x 6 V/20 Ah battery	✓	✓	✓	✓
Max. gradient	35°	35°	35°	35°
Speed	7 m/min	8 m/min	8 m/min	8 m/min
Indoor use	✓	✓	✓	✓
Outdoor use	✓	✓	✓	✓

# SPACE FOR NOTES

Write down your take-aways here

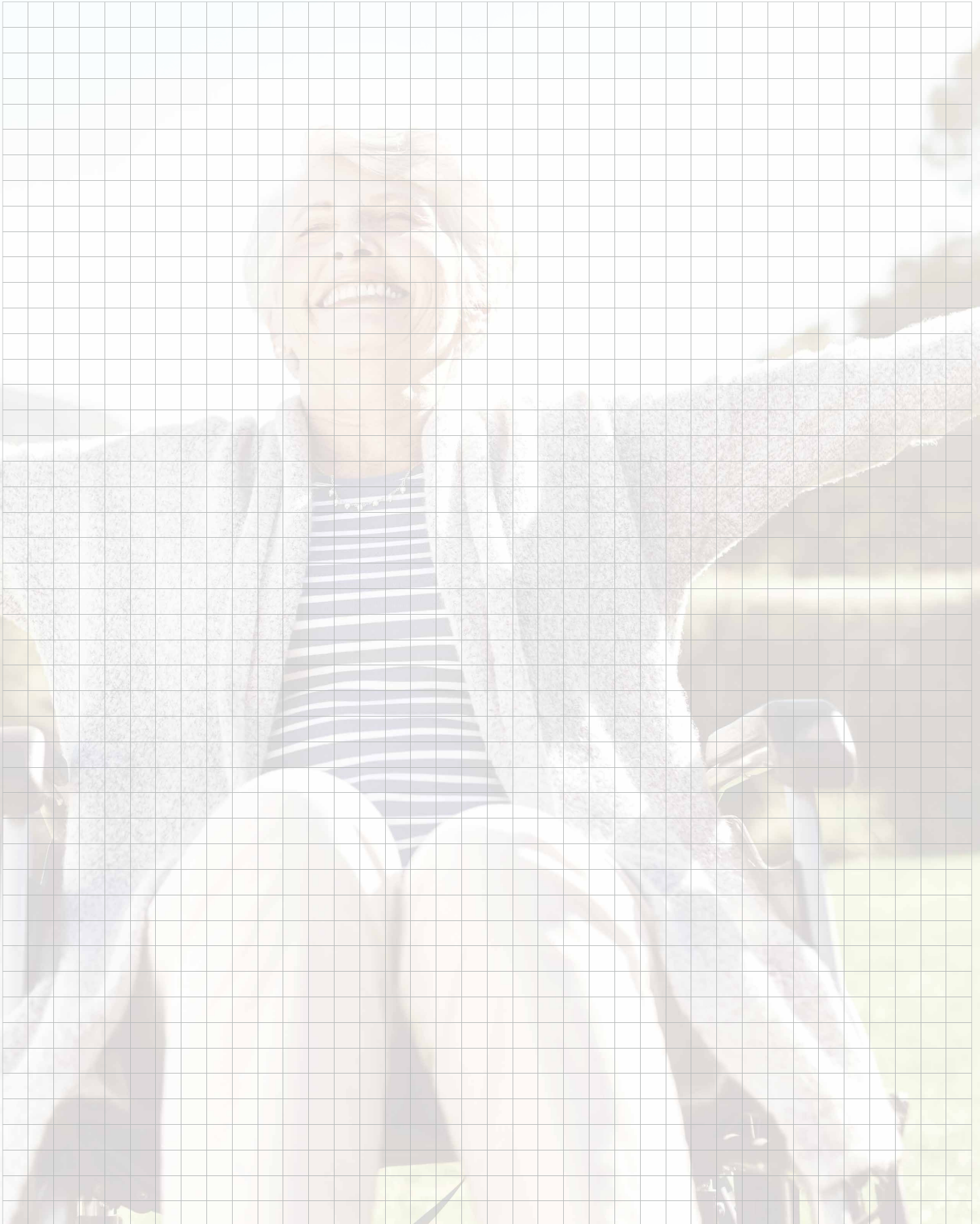





Platform stairlifts



Chair stairlifts



Vertical platformlifts



Special lifts

Official partner of:

**LEHNER**  
**LIFTTECHNIK**

Loc 1: Antelias, Seaside, SSS Bldg,  
fifth floor beside AISHTI.

Loc 2: Bchamoun, Behind Louise  
Wegmann School,  
Andalos St. - SSS Bldg.

Tel: +961 71 260 007

Email: [sales@sss-lb.com](mailto:sales@sss-lb.com)

[www.sss-lb.com](http://www.sss-lb.com)